

PRODUCT DATA SHEET

Part number 310409SL

EAN 4015609570294

Manufacturer WALTHER-WERKE

WEEE-Reg.-Number: DE 22131895

Product description

Coupler 16A 4P 9h screwless and with external cable gland



Similar image



Detailed product description

WALTHER Coupler 16A 4P 230V 9h IP44
 made from PA6 material
 screwless
 with insulation displacement technique
 and external cable gland
 Increased safety due to injected 2K seal.

Ordering Information

Order unit	Piece
Customs number	85366990
Net weight	0,261 kg
Packing quantity (VPE)	10
Length of the packaging	0,31 m
Width of the packaging	0,195 m
Depth of the packaging	0,14 m
Gross weight(VPE)	2,758 kg

Certificates

VDE/ENEC certification	40024796	
EAC certification	BY112.02.01.020 06101	

Classification system

Classification system	ETIM_6.0
ETIM Class	EC001320

Technical product data

IEC-amperage	16 A
Amperage acc. UL/CSA (for UL-version)	20 A
Number of poles	4
Voltage acc. EN 60309-2	230 V (50+60 Hz) blue
Clock hour position	9 h
Identification colour	Blue
RAL-number	5002
Degree of protection (IP)	IP44
Connection system	Screw less terminal
Angle of plug	Straight
Cable entry	Anti-kink sleeve
Material	Plastic

Dimension sheet

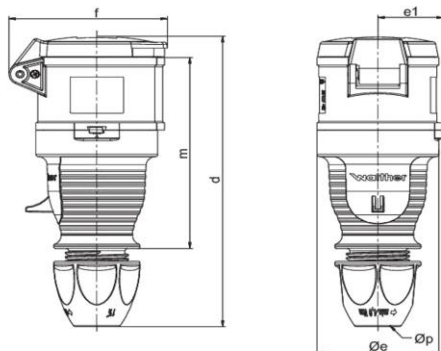

Amp.	16	16	32	32	32
Pole	4	5	3	4	5
d	165-176	165-176	189-199	189-199	189-199
Øe	65	65	72	72	72
e1	35	35	38,5	38,5	38,5
f	77	85	91	91	97
m	114	114	130	130	130
Øp	7,5 - 18,5	7,5 - 18,5	10 - 22,5	10 - 22,5	10 - 22,5